

# **STAR-LIGHT HDCOAX™ 1080p 2.1MP 20X Pan Tilt Zoom Camera DWC-PTZ20X**



## ***User's Manual*** Ver. 11/19

Before installing and using the camera, please read this manual carefully. Be sure to keep it handy for future reference.

## WARNING

TO REDUCE THE RISK OF FIRE OR ELECTRIC SHOCK, DO NOT EXPOSE THIS PRODUCT TO RAIN OR MOISTURE. DO NOT INSERT ANY METALLIC OBJECTS THROUGH THE VENTILATION GRILLS OR OTHER OPENINGS ON THE EQUIPMENT.

## CAUTION

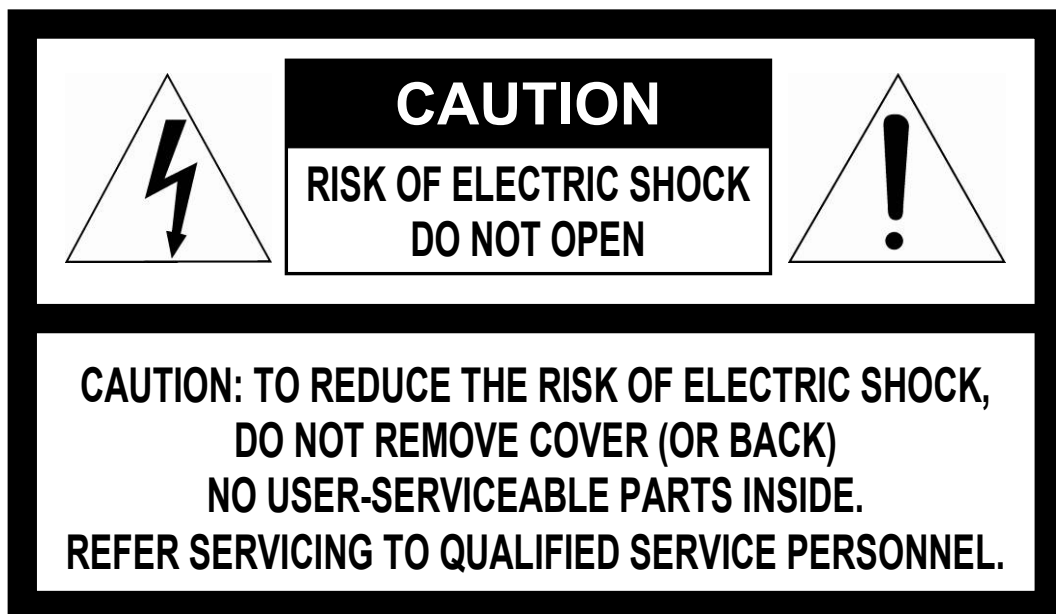

## EXPLANATION OF GRAPHICAL SYMBOLS



The lightning flash with arrowhead symbol, within an equilateral triangle, is intended to alert the user to the presence of uninsulated “dangerous voltage” within the product’s enclosure that may be of sufficient magnitude to constitute a risk of electric shock to persons.



The exclamation point within an equilateral triangle is intended to alert the user to the presence of important operating and maintenance (servicing) instructions in the literature accompanying the appliance.

## FCC COMPLIANCE STATEMENT

This device complies with Part 15 of the FCC Rules. Operation is subject to the following two conditions: (1) this device may not cause harmful interference, and (2) this device must accept any interference received, including interference that may cause undesired operation.

**FCC INFORMATION:** This equipment has been tested and found to comply with the limits for a Class A digital device, pursuant to Part 15 of the FCC Rules. These limits are designed to provide reasonable protection against harmful interference when the equipment is operated in a commercial environment. This equipment generates, uses, and can radiate radio frequency energy and, if not installed and used in accordance with the instruction manual, may cause harmful interference to radio communications. Operation of this equipment in a residential area is likely to cause harmful interference in which case the user will be required to correct the interference at his own expense.

**CAUTION:** Changes or modifications not expressly approved by the party responsible for compliance could void the user's authority to operate the equipment.

This Class A digital apparatus complies with Canadian ICES-003.

Cet appareil numérique de la classe A est conforme à la norme NMB-003 du Canada.

## CE COMPLIANCE STATEMENT

### **WARNING**

This is a Class A product. In a domestic environment this product may cause radio interference in which case the user may be required to take adequate measures.

# IMPORTANT SAFETY INSTRUCTIONS

---

1. Read these instructions.
2. Keep these instructions.
3. Heed all warnings.
4. Follow all instructions.
5. Do not use this apparatus near water.
6. Clean only with dry cloth.
7. Do not block any ventilation openings. Install in accordance with the manufacturer's instructions.
8. Do not install near any heat sources such as radiators, heat registers, stoves, or other apparatus (including amplifiers) that produce heat.
9. Do not defeat the safety purpose of the polarized or grounding-type plug. A polarized plug has two blades with one wider than the other. A grounding type plug has two blades and a third grounding prong. The wide blade or the third prong is provided for your safety. If the provided plug does not fit into your outlet, consult an electrician for replacement of the obsolete outlet.
10. Protect the power cord from being walked on or pinched particularly at plugs, convenience receptacles, and the point where they exit from the apparatus.
11. Only use attachments/accessories specified by the manufacturer.
12. Use only with the cart, stand, tripod, bracket, or table specified by the manufacturer, or sold with the apparatus. When a cart is used, use caution when moving the cart/apparatus combination to avoid injury from tip-over.
13. Unplug this apparatus during lightning storms or when unused for long periods of time.
14. Refer all servicing to qualified service personnel. Servicing is required when the apparatus has been damaged in any way, such as power-supply cord or plug is damaged, liquid has been spilled or objects have fallen into the apparatus, the apparatus has been exposed to rain or moisture, does not operate normally, or has been dropped.
15. **CAUTION – THESE SERVICING INSTRUCTIONS ARE FOR USE BY QUALIFIED SERVICE PERSONNEL ONLY. TO REDUCE THE RISK OF ELECTRIC SHOCK DO NOT PERFORM ANY SERVICING OTHER THAN THAT CONTAINED IN THE OPERATING INSTRUCTIONS UNLESS YOU ARE QUALIFIED TO DO SO.**
16. **Use satisfy clause 2.5 of IEC60950-1/UL60950-1 or Certified/Listed Class 2 power source only.**



# Table of Contents

<b>Chapter 1 — Introduction .....</b>	<b>6</b>
<b>1.1 Features.....</b>	<b>6</b>
<b>Chapter 2 — Installation and Configuration .....</b>	<b>7</b>
<b>2.1 Package Contents .....</b>	<b>7</b>
<b>2.2 Mounting the Camera .....</b>	<b>8</b>
<b>2.2.1 Locking the Camera.....</b>	<b>8</b>
<b>2.3 Basic Configuration of Dome Camera System.....</b>	<b>10</b>
<b>2.4 Setting Dome Camera Address (ID .....</b>	<b>11</b>
<b>2.5 Setting Dome Camera Video Signal &amp; Coaxitron Protocol.....</b>	<b>11</b>
<b>2.6 Connections.....</b>	<b>12</b>
<b>2.7 Getting Started .....</b>	<b>13</b>
<b>Chapter 3 — Program and Operation .....</b>	<b>14</b>
<b>3.1 Accessing the On-Screen Menu Utility.....</b>	<b>14</b>
<b>3.2 How to control the On-Screen Menu Utility .....</b>	<b>14</b>
<b>3.3 Auto Scan .....</b>	<b>15</b>
<b>3.4 Preset .....</b>	<b>17</b>
<b>3.5 Tour .....</b>	<b>19</b>
<b>3.6 Pattern.....</b>	<b>21</b>
<b>3.7 Privacy Zone .....</b>	<b>22</b>
<b>3.8 Camera Menu.....</b>	<b>23</b>
<b>3.9 Dome Communication .....</b>	<b>26</b>
<b>3.10 Alarm.....</b>	<b>27</b>
<b>3.11 Dome Setup.....</b>	<b>28</b>
<b>Appendix A — Dimensions .....</b>	<b>35</b>
<b>Appendix B — Troubleshooting.....</b>	<b>36</b>

# Chapter 1 — Introduction

## 1.1 Features

- Analog HD over Coax Technology with AHD/TVI Signal Support
- 1/2.8" Image Sensor (1080p, 30fps)
- 2.1MP, 1080p Resolution at 30fps
- STAR-LIGHT™ Super Low Light Technology
- 4.7 ~ 94mm Remote Auto Focus Lens
- 20x Optical Zoom + 16x Digital Zoom
- Wide Dynamic Range (WDR)
- Smart DNR™ 3D Digital Noise Reduction
- True Day/Night with Mechanical IR Cut Filter
- Pan 0~360° Endless, 380° Per Second Pan Speed
- Vector Drive Technology – Pan/Tilt Motion in Shortest Path
- 240 Preset Positions, 8 Patterns, 8 Tours, 16 Auto Scans
- 4 Alarm Sensor Input
- 2 Relay Output
- Auto Sensing 24VAC/12VDC with Line Lock
- Secondary Video-BNC Output
- Easy Icon Driven OSD Menu with Built-in Joystick
- Programmable Privacy Zones
- Motion Detection
- Auto Gain Control (AGC)
- Backlight Compensation (BLC)
- Auto White Balance (AWB)
- RS-485 Built-in
- IP66 Certified (Weather Resistant)
- 180° Digital Flip
- Use satisfy clause 2.5 of IEC60950-1/UL60950-1 or Certified/Listed Class 2 power source only.

# Chapter 2 — Installation and Configuration

## 2.1 Package Contents

Digital Watchdog’s 20x HD over Coax pan, tilt, zoom dome camera is designed with compact, small size, hard dome camera housing.

The housing is constructed of aluminum, steel and plastic. The housing is designed to be mounted on a wall or a ceiling. The housing meets the Protection Classification IP66 standards for dust and moisture resistance.

Before installing the camera, make sure the box includes the following:

* <b>Dome Camera</b> .....	<b>1</b>
* <b>Instruction Manual (Quick Start Guide)</b> .....	<b>1</b>
* <b>Mounting Template Sheet</b> .....	<b>1</b>
* <b>Mounting Bracket</b> .....	<b>1</b>
* <b>Safety Lanyard</b> .....	<b>1</b>
* <b>Accessory Kit</b> .....	<b>1</b>
1) Mounting screws (PH6 x 35.0) .....	(4)
2) Plastic anchors .....	(4)
3) O-Rings .....	(4)
4) Torx wrench .....	(1)
* <b>Accessory Connector</b> .....	<b>1</b>
1) 2-Pin Terminal Block .....	(1)
2) 3-Pin Terminal Block .....	(1)
3) 4-Pin Terminal Block .....	(1)
4) 5-Pin Terminal Block .....	(1)

## 2.2 Mounting the Camera

The dome camera is for use in surface or pendent mounting applications, and the mounting surface must be capable of supporting loads of up to 10 lb (4.5 kg). (Wall mount and ceiling mount are sold separately.)

The dome camera's mounting bracket should be attached to a structural object, such as hard wood, wall stud or ceiling rafter that supports the weight of the dome camera.

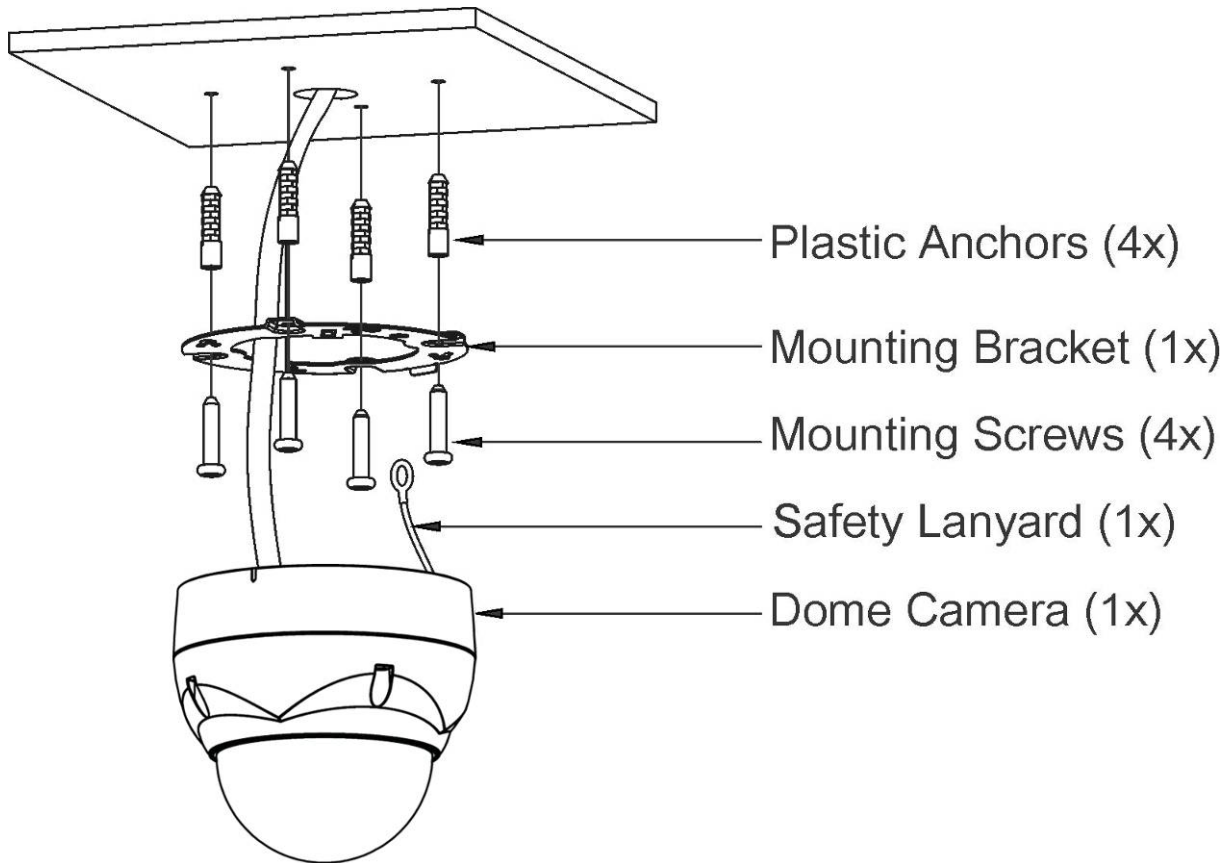

**CAUTION: A silicone rubber sealant must be applied to seal the housing to secure waterproofing.**

### 2.2.1 Locking the Camera

1. Using the supplied mounting Template Sheet, mark and screw holes on the mounting surface (Figure A).
2. Fix the Mounting Bracket to the mounting surface using the supplied anchors (4x) and mounting screws (4x) (Figure B).
3. Hook up the Safety Lanyard to the Safety Lanyard Hook of the Mounting Bracket (Figure C).
4. Align the locking tab on the bracket and the locking slot on the base of the dome (Figure D).
5. Turn the dome counterclockwise about 10 degrees to lock it in position (Figure E).



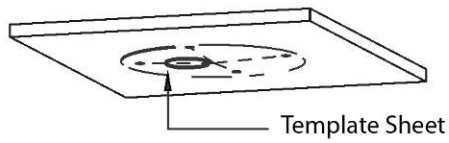

Figure A

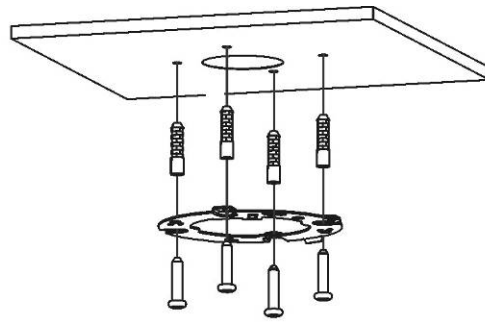

Figure B

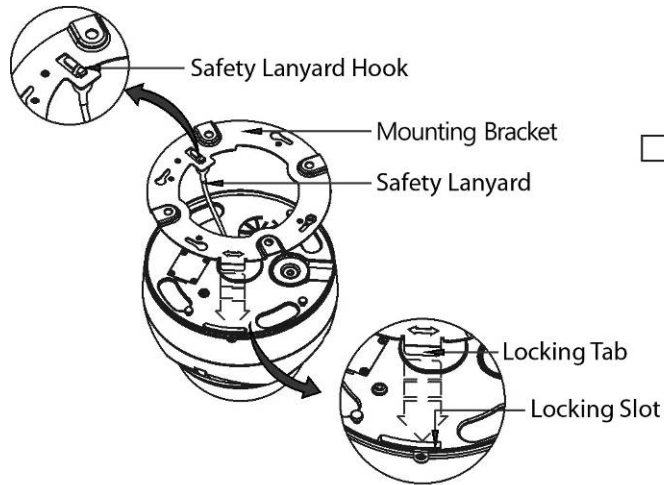

Figure C

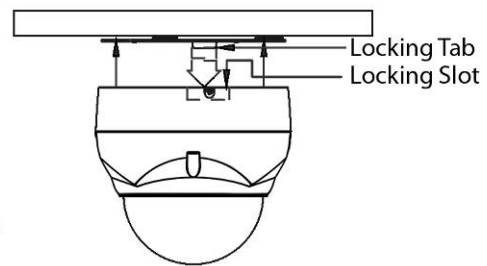

Figure D

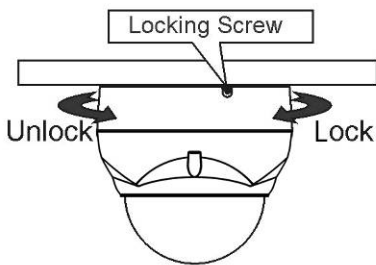

Figure E

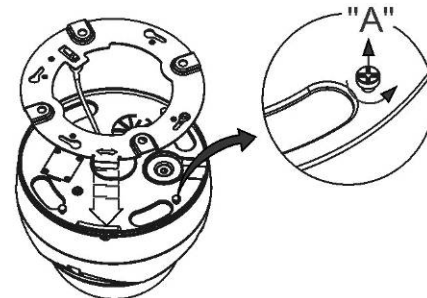
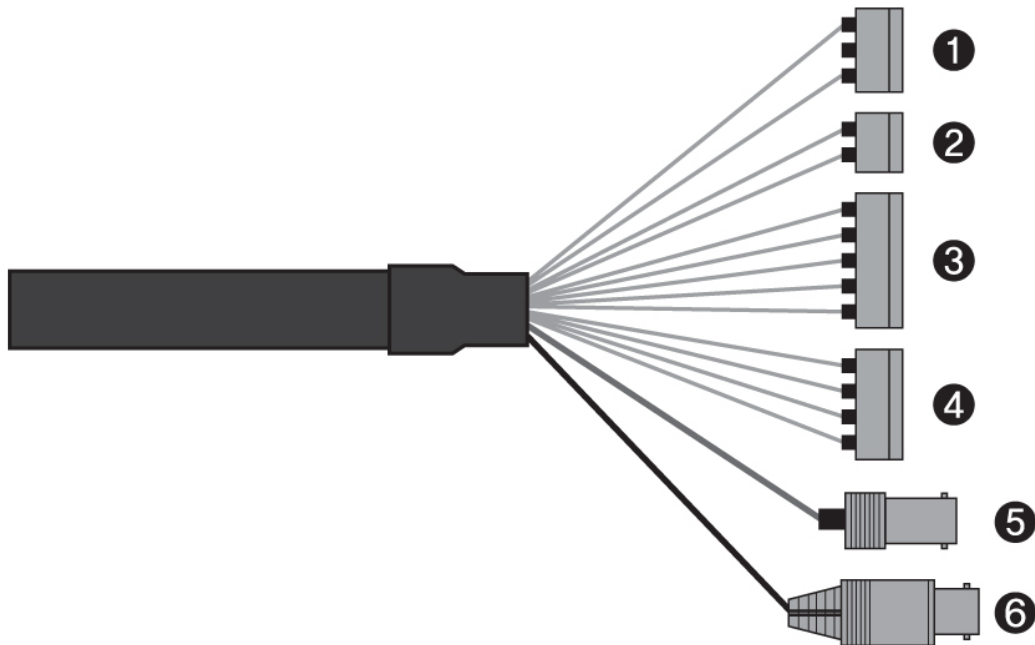

Figure F

**CAUTION:** Before installing the mounting bracket to the surface, pre-adjust the four mounting screws "A" on the base of the camera to best match the mounting bracket locked position. Unscrew the locking screw on the side of the dome's base and fit the tab of the mounting bracket into the locking slot. Screws "A" should not be too tight or too loose when the dome is in locked position. After setting the proper positions of screws "A", remove the mounting bracket and install it to the mounting surface. If it is too difficult to lock the dome in position after the mounting bracket has been installed, readjust the screws "A" by slightly unscrewing them and try to install dome camera again.

## 2.3 Basic Configuration of Dome Camera System



No.	Connector	Wire Color	Description
1	3-pin terminal block	RED	24VAC or 12VDC+
		WHITE	24VAC or 12VDC-
2	2-pin terminal block	GREEN	RS-485+
		BLUE	RS-485-
3	5-pin terminal block	GRAY	ALARM INPUT 1
		VIOLET	ALARM INPUT 2
		ORANGE	ALARM INPUT 3
		SKY BLUE	ALARM INPUT 4
		BLACK	GND
4	4-pin terminal block	YELLOW	ALARM OUTPUT 1
		BLACK & WHITE	GND
		SKY BLUE & BALCK	ALARM OUTPUT 2
		ORANGE & BLACK	GND
5	BNC jack	BLUE	HD-TVI/AHD OUTPUT
6	BNC jack	BLACK	CVBS OUTPUT

The camera must be installed by a qualified service personnel in accordance with all local and federal electrical and building codes.

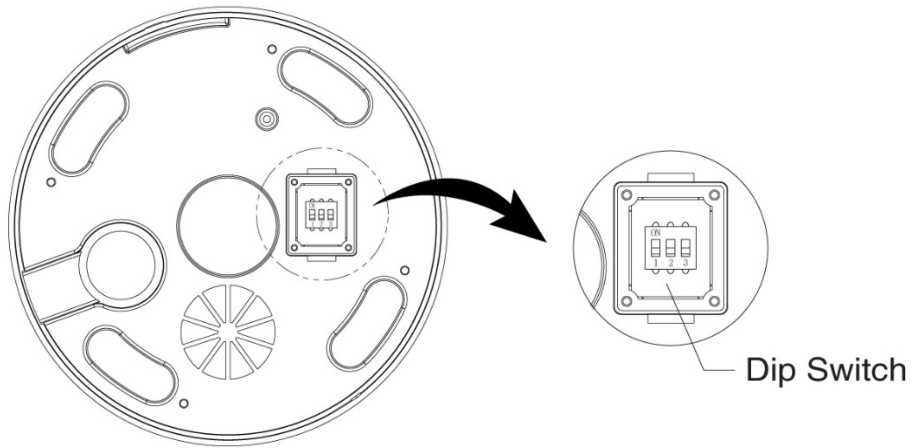

**NOTE:** Open the DIP switch cover and change the setting of the DIP switch as needed. The cover should be closed after setting DIP switch.

## 2.4 Setting Dome Camera Address (ID)

To prevent damage, each dome camera must have a unique address (ID). The factory default ID is 1.

Refer to '3.9 Dome Communication' section for detailed information.

## 2.5 Setting Dome Camera Video Signal & Coaxitron Protocol

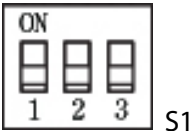

You can set the video signal with D1 in S1.

S1-D1	Video Signal
OFF	HD-TVI OUTPUT
<b>ON</b>	HD-ANALOG OUTPUT

You can set coaxitron protocol with D2 and D3 in S1.

S1-D2	S1-D3	HD-TVI OUTPUT	AHD OUTPUT
OFF	OFF	TVI-C	A_CP-PTZ
<b>ON</b>	OFF	Pelco-C	Reserved
OFF	<b>ON</b>	Reserved	Reserved
<b>ON</b>	<b>ON</b>	Reserved	Reserved

## 2.6 Connections

### • Connecting to the RS-485

The dome camera can be controlled remotely by an external device or control system using RS-485 half-duplex serial communications signals.

### • Connecting HD-TVI/HD-ANALOG Output connector

Connect the HD-TVI/HD-ANALOG output (BNC) connector to the monitor or video input.

### • Connecting CVBS Output connector

Connect the CVBS output (BNC) connector to the monitor or video input.

### • Connecting Alarms

#### - A1, A2, A3, A4 (Alarm Input 1, 2, 3, 4)

You can use external devices to signal the dome camera to react on events. Mechanical or electrical switches can be wired to the A1, A2, A3, A4 (Alarm Input 1, 2, 3, 4) and G (Ground) connectors.

See Chapter 3 — Program and Operation for configuring alarm input for more information.

#### - G (Ground)

**NOTE: All the connectors marked G or GND are common.**

Connect the ground side of the alarm input and/or alarm output to the G (Ground) connector.

#### - AO1, AO2 (5VTTL Alarm Output 1, 2)

The dome camera can activate external devices such as buzzers or lights. Connect the device to the AO1, AO2 (Alarm Output 1, 2) and G (Ground) connectors.

See Chapter 3 — Program and Operation for configuring alarm output.

### • Connecting the Power

Connect power of 12VDC or 24VAC to the dome camera.

When using a 12VDC adapter, connect the positive (+) pole to the '+' position and the negative (-) pole to the '-' position.

Use satisfy clause 2.5 of IEC60950-1/UL60950-1 or Certified/Listed Class 2 power source only.

24VAC is recommended for stable operation when using a heater kit.

If using 12VDC, the heater will not operate at all.

## 2.7 Getting Started

Once the camera is properly installed, apply power to the dome camera. The dome camera will start a configuration sequence.

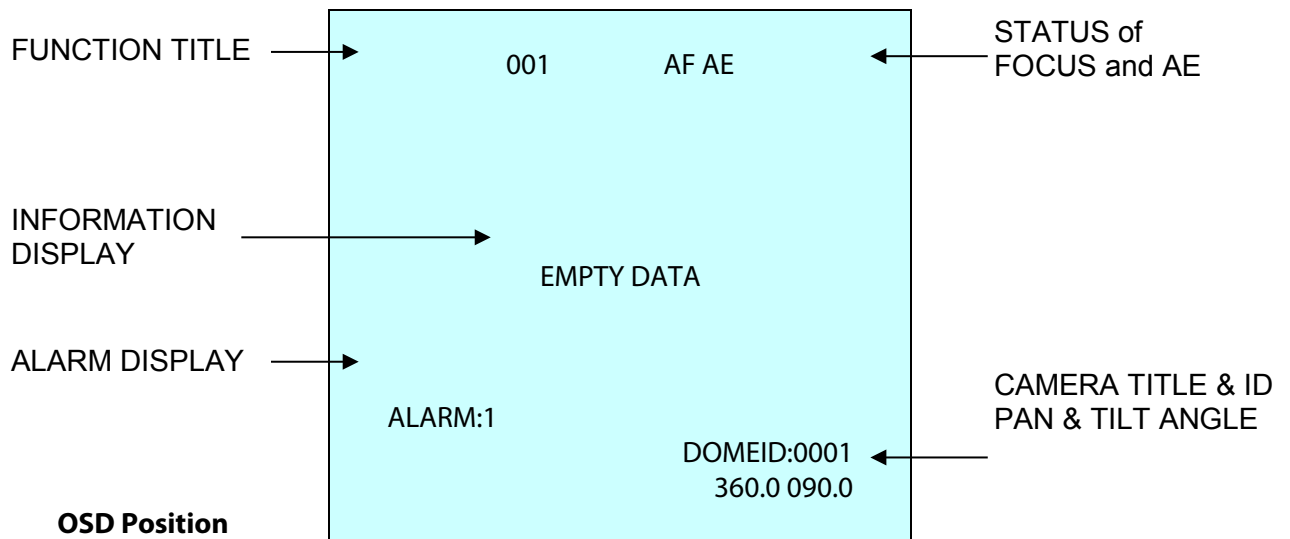

## Chapter 3 — Program and Operation

### 3.1 Accessing the On-Screen Menu Utility

You can call up the On-screen menu utility on your monitor by pressing the **MENU** key, the following On-screen menu will appear:

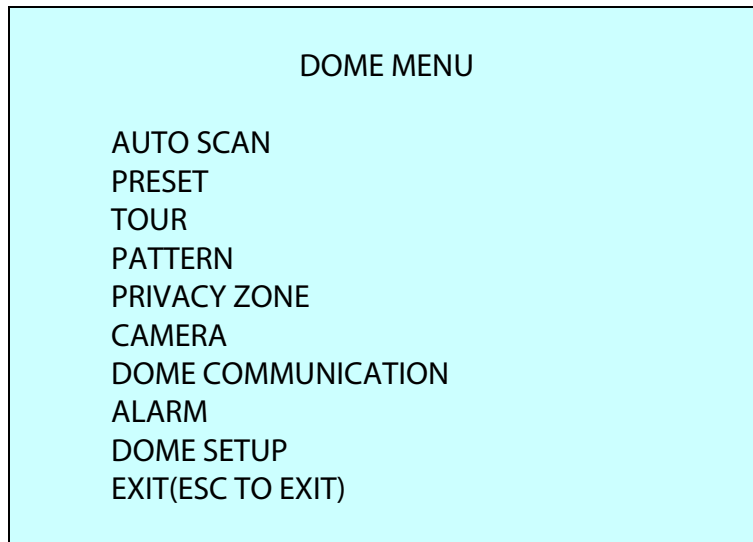

### 3.2 How to control the On-Screen Menu Utility

Function	Button
Call the On-screen menu utility.	<b>MENU</b>
Navigate through the menu items.	<b>Up, Down</b>
Go into the sub-menu items.	<b>Left, Right or IRIS Open</b>
Change value. Enter the editing title mode.	<b>Left, Right or Tele , Wide</b>
Enter the changing angle mode.	<b>IRIS Open</b>
Exit the changing angle mode.	<b>IRIS Close</b>

### 3.3 Auto Scan

The Auto Scan supports up to 17 programmed angles at different speeds. To setup an Auto Scan:

```

                                AUTO SCAN SETUP

NUMBER      :01
TITLE       :A01
MODE        :NORMAL
SPEED       :5 STEP
START ANGLE :-----
END ANGLE   :-----
SCAN DIR    :CCW
SWAP        :OFF
DWELL       :03 SEC
FOCUS       :AUTO
SAVE AND EXIT(ESC TO CANCEL)

```

- NUMBER**     01 ~ 08, 10 ~ 17, **09**: AUTO-PAN mode.
- TITLE**        up to 6 characters
- MODE**         NORMAL, VECTOR, RANDOM (AUTO-PAN mode: NORMAL, RANDOM only).
  - NORMAL        Move from start point to end point in panning only
  - VECTOR        Move from start point to end point with tilt and zoom simultaneously and linearly.
  - RANDOM        Move randomly between the start point and the end point
- SPEED**        1 ~ 13, the lower number the slower the camera will move.
- SCAN DIR**     Set the Scan direction, CCW (Counter Clock Wise), CW (Clock Wise).
- SWAP**         Swaps the start point for the end point.
- DWELL**        Set the dwell time at both start and end points, 01 ~ 99 seconds.
- FOCUS**        AUTO, MANUAL

1. Press **MENU** to display the main menu on the monitor. Scroll to Auto Scan and press the **Right** key.
2. Select "**NUMBER**" and set the desired number by pressing the **Left** or **Right** key.
3. Select "**TITLE**" and press the **Tele** or **Wide** key to enter the title edit mode.
4. Press **Tele** or **Wide** to change the alphanumeric characters. Move to the next position by pressing the **Left** or **Right** key or move down to the character table and press the **IRIS Open** key at the desired character. The cursor position will move to the next position automatically. Press the **Left** or **Right** key at the "ALL DELETE" to delete all characters. Press **Left** or **Right** at the "EXIT" field to finish title edit menu.

```

                                TITLE EDIT MENU
                                (CTRL KEY)

                                A01
                                *

                                A B C D E F G H I J
                                K L M N O P Q R S T
                                U V W X Y Z 0 1 2 3
                                4 5 6 7 8 9 ( )
                                ALL DELETE
                                EXIT(ESC TO EXIT)

```

5. Select "**MODE**" and "**SPEED**".
6. Select "**START ANGLE**". Press the **IRIS Open** key to go to the "CONTROL" settings. Move the desired position and the zoom position. Press the **IRIS Close** key then the "CONTROL" disappears. To adjust at the 0.1 degree interval, press the **Tele** or **Wide** key at the pan field and the tilt field.
7. Select "**END ANGLE**". Press the **IRIS Open** key to go to the "CONTROL" settings. Move the desired position and the zoom position. Press the **IRIS Close** key then the "CONTROL" disappears. To adjust at the 0.1 degree interval, press the **Tele** or **Wide** key at the pan field and the tilt field.
8. Set "**SCAN DIR**" to CCW or CW.
9. Select "**SWAP**", Set to ON to exchange the start angle and the end angle.
10. Set "**DWELL time**".
11. Set "**FOCUS**".
12. Select "**SAVE AND EXIT**" and press the **Right** key.

**NOTE: 09: AUTO-PAN mode (endless panning)**



### 3.4 Preset

If you need to view specific places routinely, you should program Presets. A Preset is a programmed video scene with automatic pan, tilt, zoom, focus, and AE settings. Once programmed, placing the number position and pressing the **PRST** key will move the camera to the set scene and adjust the camera's settings automatically. In addition, Presets may be assigned as a "home" position. Users can setup up to 240 individual presets.

There are eight pages of Preset menu. Each page has 30 Presets. Pages can be scrolled by pressing the **Left** or **Right** key on the first or last No. of Preset.

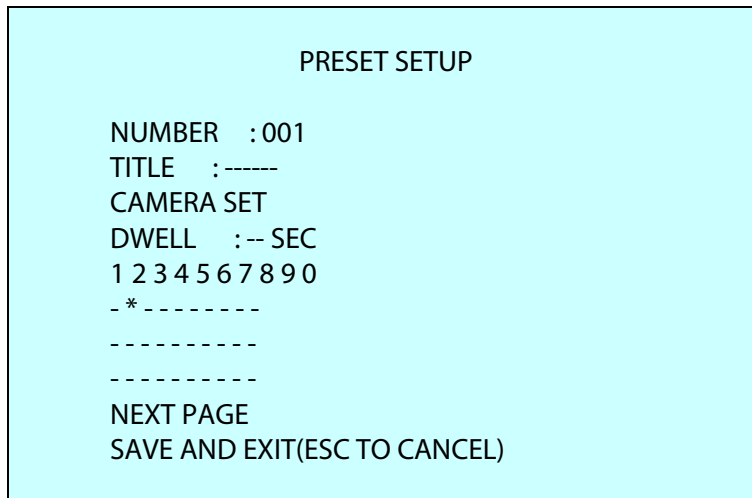

- Blank Preset position
- \* Position has the Preset
- ! Current cursor position

Follow steps below to store the Preset positions:

1. Press the **MENU** key to display the main menu on the monitor. Scroll to Preset and press the **Right** key.
2. Select the blank Preset position to be stored by pressing the **Up, Down, Right** or **Left** key.
3. After selecting a blank position, press the **IRIS Open** key. Use the **Up, Down, Right, Left, Tele** or **Wide** key to control the direction of the camera and lens.
4. After aiming the camera (view direction and lens control), press the **IRIS Close** key. The cursor will be on the **"TITLE"** after saving data then press the **Tele** or **Wide** key to edit the Preset title. Follow the procedure of the Auto Scan above to edit titles.
5. Select **"CAMERA SET"** and press the **Left** or **Right** key. Then the Preset camera setup will be displayed.

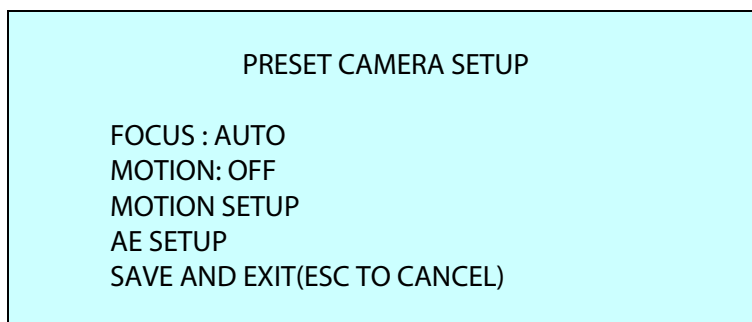

- Set **FOCUS** AUTO, MANUAL, ONE PUSH
- Set **MOTION** OFF, ON

Select "**MOTION SETUP**" and press the **Left** or **Right** key. Then the MOTION setup displays.

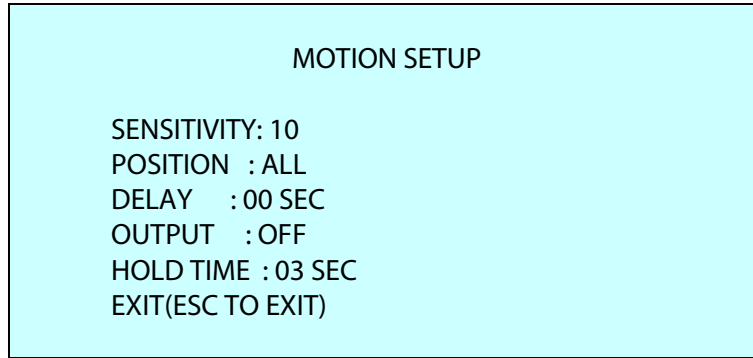

Set <b>SENSITIVITY</b>	00 ~ 20
Set <b>POSITION</b>	ALL, CENTER
Set <b>DELAY</b>	00 ~ 05 seconds
Set <b>OUTPUT</b>	OFF, OUT1, OUT2
Set <b>HOLD TIME</b>	03 ~ 99 seconds

Select "**AE SETUP**" and press the **Left** or **Right** key. Then the AE setup displays. Refer to the AE SETUP in the camera setup.

6. Set "**DWELL time**". (03 ~ 99 seconds)
7. To select the next page of Presets, scroll the page by pressing the **Left** or **Right** key on the first or last columns of the menu.
8. Repeat step 2 through 7 for each additional Preset position.
9. Select "**SAVE AND EXIT**" and press the **Right** key.

**NOTE: Press the HOME key at programmed Preset position (\*) to delete a programmed Preset.**

### 3.5 Tour

There are 8 programmable Tours. Each Tour consists of up to 40 Preset positions, Patterns, Scans or other Tours (second-level). Using second-level Tours, it can be expanded to over 300 functions in a single Tour.

```

                                TOUR SETUP

NUMBER      :01
TITLE       :T01
SCAN TYPE   :NORMAL
SPEED       :-- STEP
TOUR FUNC
SAVE AND EXIT(ESC TO CANCEL)
  
```

```

                                TOUR FUNC SETUP
                                                (CTRL KEY)

DWELL       :-- SEC
003 A04 ----
-----
----- P01 ----
--- T02 ----
-----
-----
-----
EXIT(ESC TO EXIT)
  
```

---	Blank position
SCAN TYPE	NORMAL, VECTOR
DWELL	03 ~ 99 seconds
003	Preset (1 ~ 240)
A04	Auto Scan (1 ~ 8, 10 ~ 17)
P01	Pattern (1 ~ 8)
T02	Tour (1 ~ 8)

Follow the steps below to program the Tours:

1. Press the **MENU** key to display the main menu on the monitor. Scroll to Tour and press the **Right** key to enter the Tour menu.
2. Select "**NUMBER**" and set the desired number by pressing the **Left** or **Right** key.
3. Choose a blank position to be programmed by pressing the **Up, Down, Right** or **Left** key.
4. To add a Preset, press the **Tele** or **Wide** key then the stored Preset number displays.
5. To place functions other than Preset, press the **IRIS Open** key to scroll for Tour, Pattern or Auto Scan respectively.
6. You can also overwrite the programmed number and remove a stored number from the Tour, press the **IRIS Open** key until '---' is displaying in the position.
7. Repeat step 2 through 6 for each desired position. Each title will be displayed on top of the line.

8. To edit the **"TITLE"**, follow the procedure of the Auto Scan above to edit titles.
9. Select **"SAVE AND EXIT"** and press the **Right** key.

You can expand the Tour sequence by calling other programmed Tours.

**NOTE: The speed applies in the vector mode only.**

**NOTE: In Tour mode, in conjunction with Preset and Auto Scan, you can make the camera travel from a Preset to another Preset at a specific speed.**

**Example:** Preset 001>002>003>004>005>006, Auto Scan 01 starts at Preset 002, ends at Preset 003, Auto Scan 02 starts at Preset 005, ends at Preset 006;  
Tour 001, 002, A01, 004, A02.

1 → 2 2~3 → 4 → 5~6, repeat  
where → : Quick move, ~ : Programmed speed

**To assign the functions other than Preset in the Tour when the function key is not existed:**

Move the cursor to a stored Preset.

Pressing the **IRIS Open** key will change the Preset number to other function (Auto Scan, Pattern, Tour or Preset) with the first programmed number.

To change the number, press the **Tele** or **Wide** key.

### 3.6 Pattern

The Pattern feature records the user's control of the camera. Up to 8 Patterns can be stored and played back by pressing **No. + PTRN** keys subsequently.

PATTERN SETUP				(CTRL KEY)
NO	TITLE	SEC	PERCENT	
1	: P01	000	00.0%	
2	: P02	000	00.0%	
3	: P03	000	00.0%	
4	: P04	000	00.0%	
5	: P05	000	00.0%	
6	: P06	000	00.0%	
7	: P07	000	00.0%	
8	: P08	000	00.0%	
SAVE AND EXIT(ESC TO CANCEL)				

Follow steps below to program the Pattern:

1. Press **MENU** to display the main menu on the monitor. Scroll to Pattern and press the **Right** key to enter the Pattern menu.
2. Select the desired Pattern to be programmed by pressing the **Up** or **Down** key. If the Pattern is not 000, a Pattern has already been recorded. Patterns can be overwritten.
3. Press the **IRIS Open** key then the "CONTROL" displays. Move the position and the zoom position. Press the **IRIS Close** key then the "CONTROL" disappears.
4. To edit the "**TITLE**", follow the procedure of the Auto Scan above to edit titles.
5. Select "**SAVE AND EXIT**" and press the **Right** key.

**NOTE: If Pattern recording time reaches 500 seconds, it will automatically stop for a moment.**

### 3.7 Privacy Zone

Hide up to 16 private scenes in a camera's view.

There are four pages of Privacy Zone menu. Each page has 4 Privacy Zones.

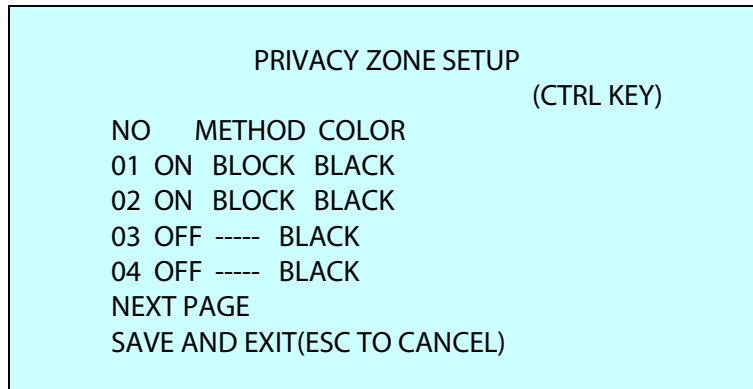

1. Place the cursor at the field.
2. Press the **IRIS Open** key then the privacy area menu displays. Move the desired position. Press the **IRIS Close** key then the "CONTROL" disappears.

To adjust the size, press the **Tele** or **Wide** key.

Returns to the previous menu.

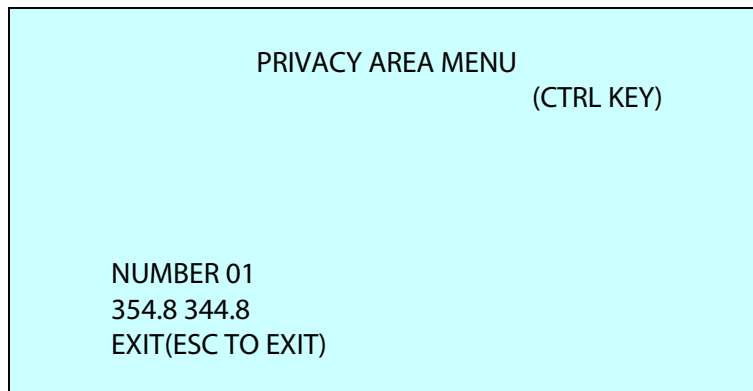

3. To turn the stored zone ON or OFF, press the **Tele** or **Wide** key.
4. Set the "**COLOR**": "BLACK", "WHITE", "YELLOW", "CYAN", "GREEN", "MAGENTA", "RED" or "BLUE".
5. Select "**SAVE AND EXIT**" and press the **Right** key.

### 3.8 Camera Menu

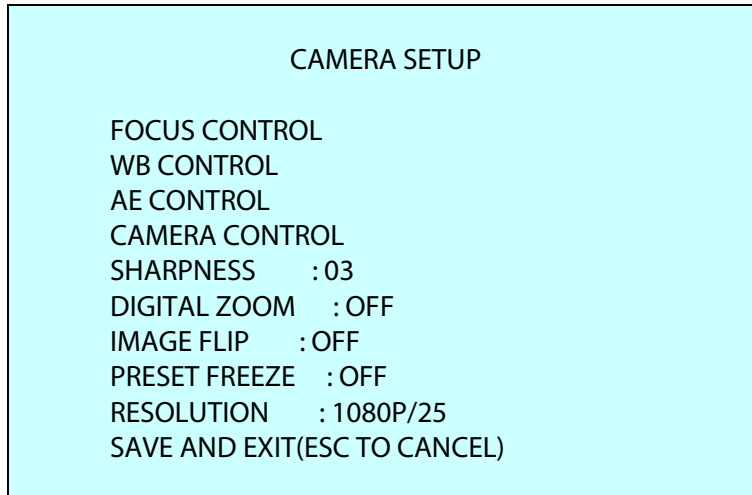

- SHARPNESS**            The higher the value, the more edges in the picture will be enhanced.  
(0 ~ 10)
- DIGITAL ZOOM**        OFF: Zoom range is limited to the optical.  
2X: Zoom is extendable up to 2X of digital range.  
4X: Zoom is extendable up to 4X of digital range.  
8X: Zoom is extendable up to 8X of digital range.  
MAX: Zoom is extendable Max digital zoom range.
- IMAGE FLIP**            Turn the camera’s video output upside down and reverses it horizontally.  
**This option is helpful when the camera is installed upside down.**
- PRESET FREEZE**        ON: the image is frozen during calling Preset.
- RESOLUTION**            HD-TVI Output: 1080P/30, 1080P/25, 720P/60, 720P/50, 720P/30, 720P/25  
HD-ANALOG Output: 1080P/30, 1080P/25

#### • FOCUS CONTROL

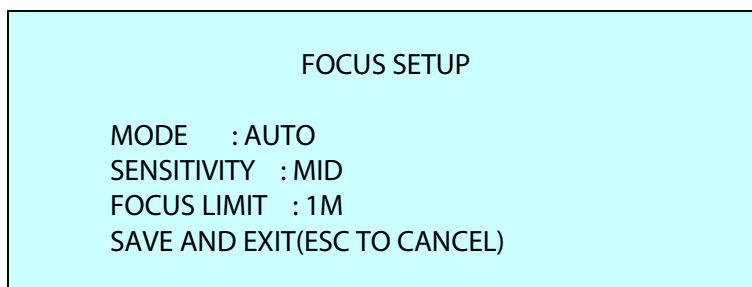

- MODE**                    AUTO, MANUAL, ONE PUSH, CONST MANUAL  
Use manual mode in normal use.
- SENSITIVITY**            LOW, LOW.MID, MID, MID.HIGH, HIGH
- FOCUS LIMIT**            This distance is approximate value and the focus operates from the setting value.

**CAUTION: Avoid continuous, 24-hour use of the auto focus. This will shorten the lifespan of the lens.**

• **WB (White Balance) CONTROL**

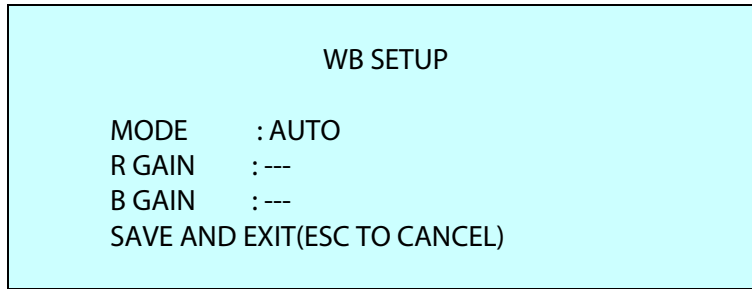

**MODE** AUTO, MANUAL, INCANDESCENT, FLUORESCENT, OUTDOOR

- AUTO Computes the white balance value output using color information from the entire screen automatically.
- INCANDESCENT Auto white balance mode that is compatible with incandescent lamps.
- FLUORESCENT Auto white balance mode that is compatible with fluorescent lamps.
- OUTDOOR Outdoor white balance mode
- MANUAL Manual mode, you can change R and B Gain manually.

R GAIN 0 ~ 255  
 B GAIN 0 ~ 255

R GAIN / B GAIN modes are controllable only in MANUAL Mode.

• **AE CONTROL**

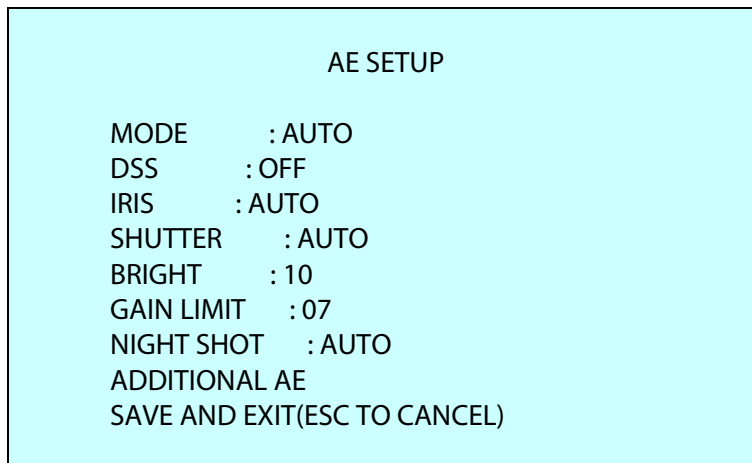

**MODE** AUTO, MANUAL, I.PRIO, S.PRIO

- AUTO Auto exposure mode
- MANUAL Variable Iris, Shutter speed
- I.PRIO Variable Iris, Auto Shutter speed
- S.PRIO Variable Shutter speed, Auto Iris

**DSS** OFF, x2 ~ x8  
**IRIS** F1.8 ~ F32  
**SHUTTER** 1/30 ~ 1/30000  
**BRIGHT** 0 ~ 20  
**GAIN LIMIT** 0 ~ 7  
**NIGHT SHOT** AUTO, ON, OFF, GLOBAL



The NIGHT SHOT option removes the IR cutoff filter of the camera and makes the camera sensitive to near infrared.

- AUTO** Camera goes in to B&W mode at low light.
- ON** B/W mode
- OFF** Color mode

**NOTE: AUTO in NIGHT SHOT function is not available when AE Control is set to "MANUAL".**

**ADDITIONAL AE**

ADDITIONAL AE SETUP	
ACE	: OFF
WDR	: OFF
WDR WEIGHT	: --
BLC	: OFF
HLC	: OFF
HLC LEVEL	: --
HLC COLOR	: ---
DEFOG	: OFF
EXIT(ESC TO EXIT)	

- ACE** OFF, LOW, MID, HIGH
- WDR** OFF, ON, NIGHT OFF (**NOTE: When ON, BLC will be disabled.**)
- WDR WEIGHT** LOW, MID, HIGH
- BLC** OFF, ON (**NOTE: When ON, WDR will be disabled.**)
- HLC** OFF, ON
- HLC LEVEL** 0 ~ 20
- HLC COLOR** BLACK, WHITE, YELLOW, CYAN, GREEN, MAGENTA, RED, BLUE
- DEFOG** OFF, ON

**• CAMERA CONTROL**

CAMERA CONROL	
D->N LEVEL	: 070
N->D LEVEL	: 030
D/N DELAY	: 03 SEC
CHROMA	: 08
GAMMA	: 2
DNR	: MID
DIS	: OFF
SAVE AND EXIT(ESC TO CANCEL)	

- D->N LEVEL** 0 ~ 255
- N->D LEVEL** 0 ~ 255
- D/N DELAY** 1 ~ 60 seconds
- CHROMA** 0 ~ 20
- GAMMA** 0 ~ 4
- DNR** OFF, LOW, MID, HIGH
- DIS** OFF, ON

### 3.9 Dome Communication

To prevent damage, each dome camera must have a unique address (ID).  
The factory default setting is 1.

```

                                DOME COMMUNICATION

                                *
DOME ID   : 0001
PROTOCOL  : AUTO
BAUDRATE  : 9600
PARITY    : NONE
TERMINATION : OFF
SAVE AND EXIT(ESC TO CANCEL)

```

<b>DOME ID</b>	1 ~ 3999
<b>PROTOCOL</b>	AUTO, F2/F2E, PELCO-PD
<b>BAUDRATE</b>	2400, 4800, 9600, 19200, 38400 bps
<b>PARITY</b>	NONE, EVEN, ODD
<b>TERMINATION (RS-485)</b>	OFF, ON

### 3.10 Alarm

```

ALARM SETUP
                                     (CTRL KEY)

NO PRI FUN IN  OUT HLD LATCH
1 1 001 NO  OUT1 03  OFF
2 1 --- OFF OFF 03  OFF
3 1 --- OFF OFF 03  OFF
4 1 --- OFF OFF 03  OFF
DWELL      : 03 SEC
ALARM OUT SETUP
SAVE AND EXIT(ESC TO CANCEL)
    
```

- NO (Number)** Alarm input number
- PRI (Priority)** The lower number has higher priority (0 ~ 4)
- FUN (Function)** Stored function number to be called by alarm.
- IN (Input)** NO/NC – normally open/closed, OFF – ignore
- OUT (Output)** OUT1 ~ OUT2 – 5VTTL output, OFF – no output
- HLD (Hold)** Alarm will be held for programmed time. (03 to 99 seconds)
- LATCH** ON – Alarm message will remain on the screen even though alarm input is deactivated.  
OFF – Alarm message will disappear from the screen after programmed hold time when alarm input is deactivated.
- DWELL** Set the dwell time during multiple alarms, 03 to 99 seconds.

```

ALARM OUT SETUP

OUT1 : ALARM
OUT2 : 1 MIN
EXIT(ESC TO EXIT)
    
```

**ALARM:** alarm output is operated during an alarm operation.  
**1 ~ 5 MIN (minute):** alarm output is operated during this setting time only by the function run of the dome menu.

**NOTE: This 1 ~ 5 MIN setting is not operated by an alarm.**

There are 5 levels of priority. The function can be selected by Preset, Auto scan, Pattern or Tour. "0" is the highest priority. Lower priority alarms won't be serviced until the higher priority alarm is completed. Equal priority alarms will be serviced repeatedly with the dwell time.

### 3.11 Dome Setup

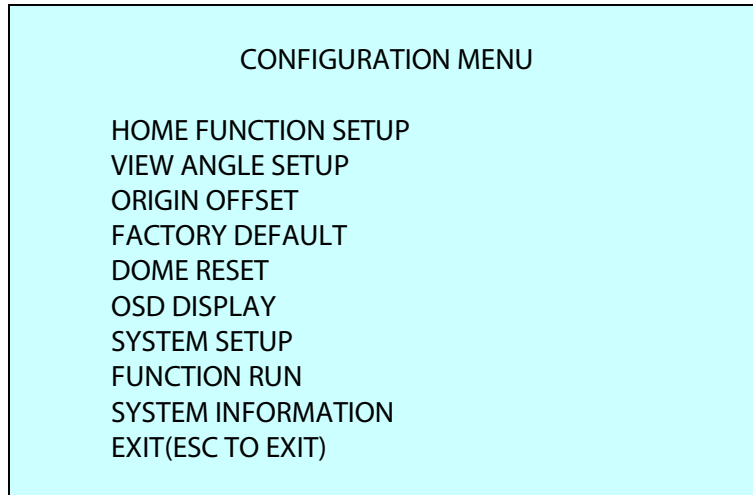

#### • HOME FUNCTION SETUP

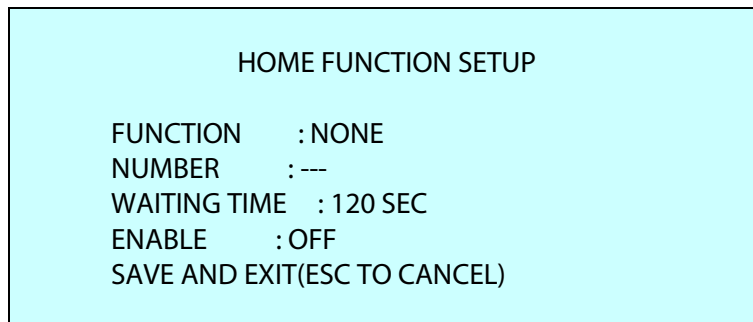

<b>FUNCTION</b>	NONE, TOUR, PATTERN, AUTO SCAN, PRESET
<b>NUMBER</b>	---
<b>WAITING TIME</b>	10 ~ 240 seconds
<b>ENABLE</b>	ON, OFF

The Home Function can be set so that the camera automatically goes to Tour, Pattern, Auto Scan or Preset.

For example, if the controller is idle for 120 seconds, the camera goes to Preset 1.

Follow these steps to program the Home position:

1. Select "**FUNCTION**" by pressing the **Left** or **Right** key to scroll through the None, Tour, Pattern, Auto Scan or Preset functions.
2. Select "**NUMBER**" and press the **Left** or **Right** key. The recorded function number will scroll.
3. Select "**WAITING TIME**" and press the **Left** or **Right** key to select from 10 to 240 seconds.
4. Select "**ENABLE**" and turn to ON or OFF by pressing the **Left** or **Right** key.

• **VIEW ANGLE SETUP**

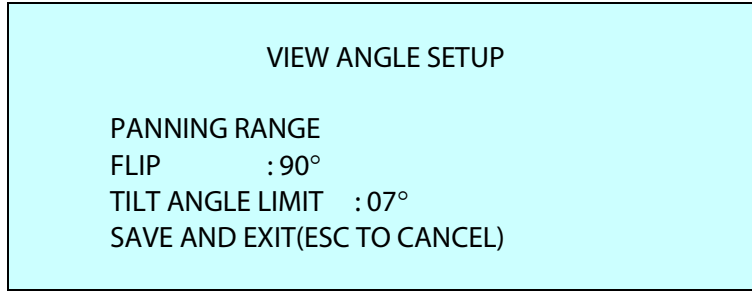

**FLIP** OFF, AUTO, 90°, 100°, 110° and 120°

**OFF:** The dome camera moves until 90° vertically.

**AUTO:** When the camera reaches the floor directly above the moving object, it will stop. At that time, pull it down again to run the auto-flip function. When you use the panning range, it is recommended to use the flip mode to AUTO.

**90°, 100°, 110° and 120°:** Allows the image to flip digitally when the camera moves over the setting angle vertically.

**TILT ANGLE LIMIT** -10° ~ 10°

This option is designed to limit the view angle as there is some obstruction in zooming out on specific areas of the tilt angle.

**NOTE:** Focus issues may occur in certain conditions.

**PANNING RANGE**

When the dome camera is installed near a wall, panning range can be limited by user.

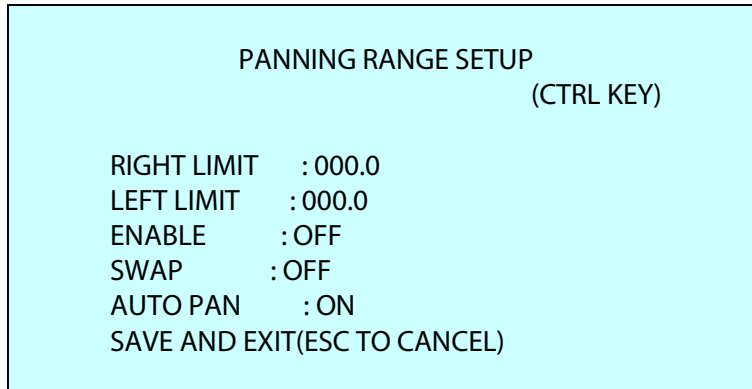

1. Place the dome camera under 90 degree vertically.
2. Set "**RIGHT LIMIT**" by pressing the **Right** key.
3. Set "**LEFT LIMIT**" by pressing the **Left** key.
4. Set "**ENABLE**" to ON to use.

To exchange the right and the left limit, set "**SWAP**" to ON.

To apply limits on the auto pan (endless panning), set "**AUTO PAN**" to ON.

**NOTE: When the flip mode is 90°, 100°, 110° or 120° and the camera's view is manually moved over 90° vertically, the panning range will operate in the opposite side.**

- **ORIGIN OFFSET**

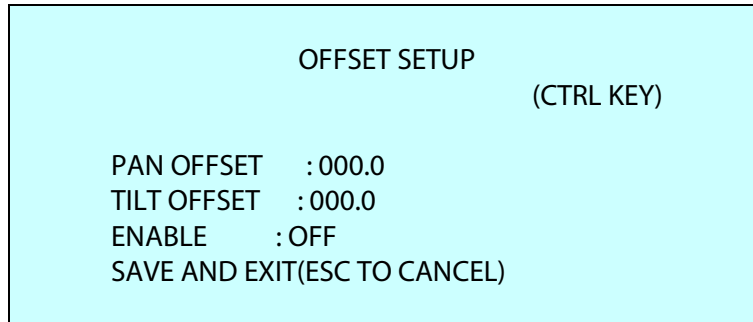

This feature helps align a new dome camera exactly the same as a previously installed camera.

Dome camera's origin set and all data initialize option do not override offset values. Only the default set option in this menu will set the offset value to zero. This can be used to avoid ceiling obstructions.

- **FACTORY DEFAULT**

Select "**FACTORY DEFAULT**" to initialize the data.

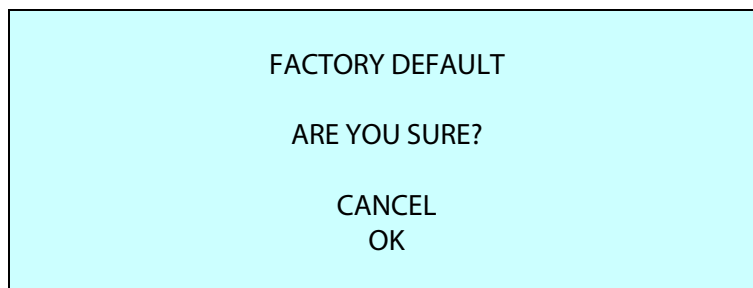

- **DOMES RESET**

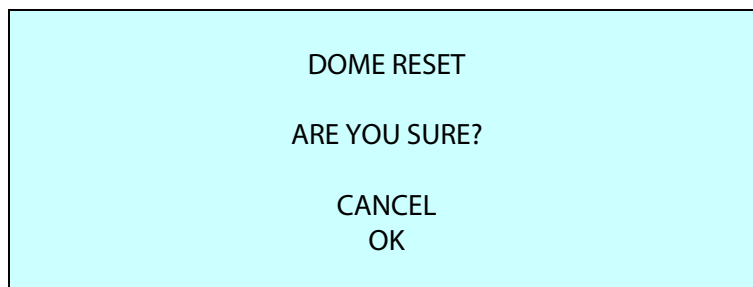

This feature is used to re-calibrate the orientation of a dome camera. Origin offset values are not affected by this function. (Offset is still valid after origin set.)

## • OSD DISPLAY

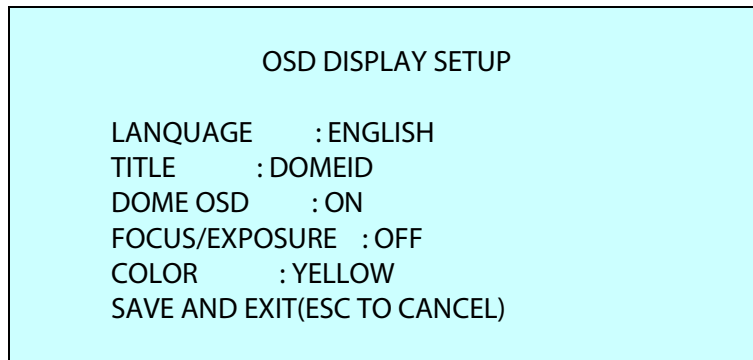

- LANGUAGE** Select the desired language.
- TITLE** up to 6 characters
- DOME OSD** ON, POSITION, ON (ZOOM), ZOOM, OFF  
All display or title will disappear when DOME OSD DISPLAY is set to OFF.
- FOCUS/EXPOSURE** ON, OFF  
ON: FOCUS and EXPOSURE displays. (AF AE)
- COLOR** YELLOW, GRAY, BLUE

## • SYSTEM SETUP

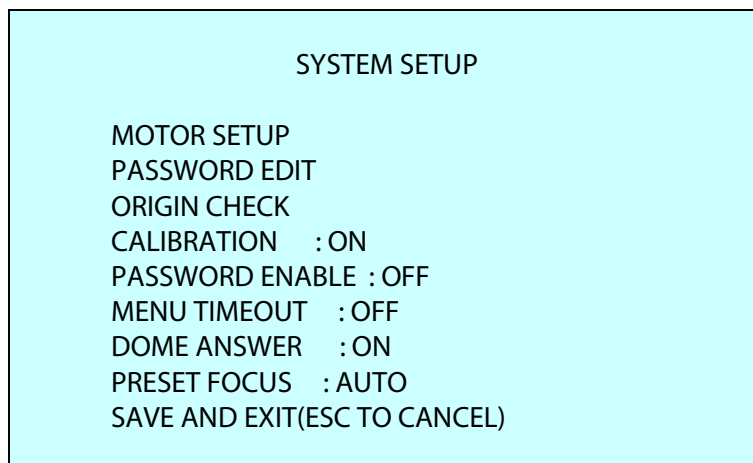

- CALIBRATION** ON (Auto origin check), OFF
- PASSWORD ENABLE** ON (requires the password to enter menu), OFF
- MENU TIMEOUT** ON (5 minutes), OFF (always menu display)
- DOME ANSWER** ON, OFF (no acknowledge command from the dome)  
This option is helpful to escape the collision of the command using some DVR.
- PRESET FOCUS** AUTO, MANUAL, ONE PUSH  
This option set the default mode of the focus when you save the Preset.

## MOTOR SETUP

Motor Setup menu provides the pan and tilt speed of a camera. User can set the desired speed with pressing the **Left** or **Right** key.

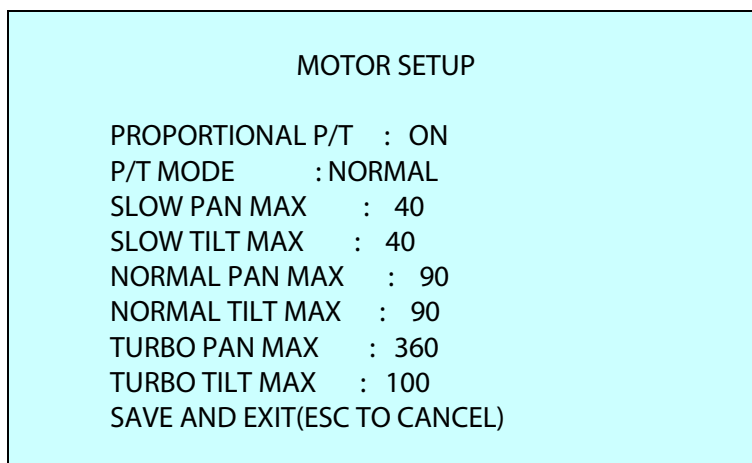

### PROPOTIONAL P/T

ON, OFF

### P/T MODE

SLOW, NORMAL, TURBO

SLOW PAN Maximum speed	19° ~ 90°/second
SLOW TILT Maximum speed	19° ~ 90°/second
NORMAL PAN Maximum speed	40° ~ 360°/second
NORMAL TILT Maximum speed	40° ~ 200°/second
TURBO PAN Maximum speed	200° ~ 380°/second
TURBO TILT Maximum speed	90° ~ 300°/second

## PASSWORD EDIT

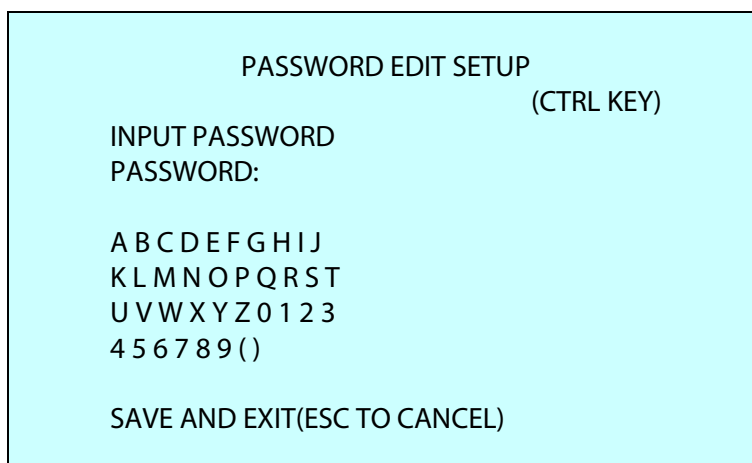

You can change the password with 6-digit character in this menu.

The default password is **555555**.

When the password enable is on, the input password window displays to enter the menu. At this time, move the cursor to the desired character and press the **IRIS Open** key.



## ORIGIN CHECK

If you find the dome in the wrong position during operation, execute this origin check and the dome camera will return to the right position after the origin check operation.

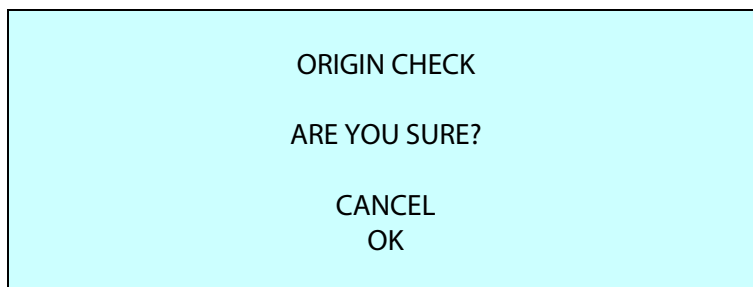

## • FUNCTION RUN

Execute the function when you use a DVR without function keys (Preset, Pattern, Tour and Scan).

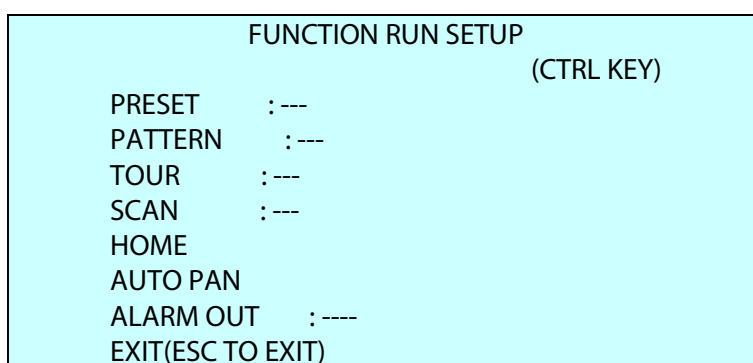

1. Select the desired Function by pressing the **Up** or **Down** key.
2. Select the number by pressing the **Tele** or **Wide** key in PRESET, PATTERN, TOUR and SCAN.
3. Press the **IRIS Open** key to execute.

**NOTE: Save the function (PRESET, PATTERN, TOUR and SCAN) before executing it.**

### - HOME

Select "HOME" and press the **IRIS Open** key. The dome camera will go to the default position after assigned period of inactivity passes. The default position may be a Preset, Tour, Pattern or no action.

### - AUTO PAN

You can execute the endless auto pan to turn in one direction continuously by selecting Auto-Pan.

### - ALARM OUT

This function can operate only when the alarm out setup has the time in the alarm menu.

Ex)

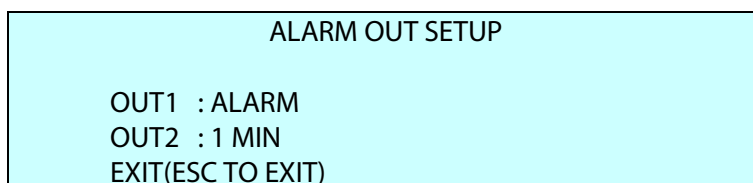

Press the **IRIS Open** key, then that alarm out will operate during setting time only.

- **SYSTEM INFORMATION**

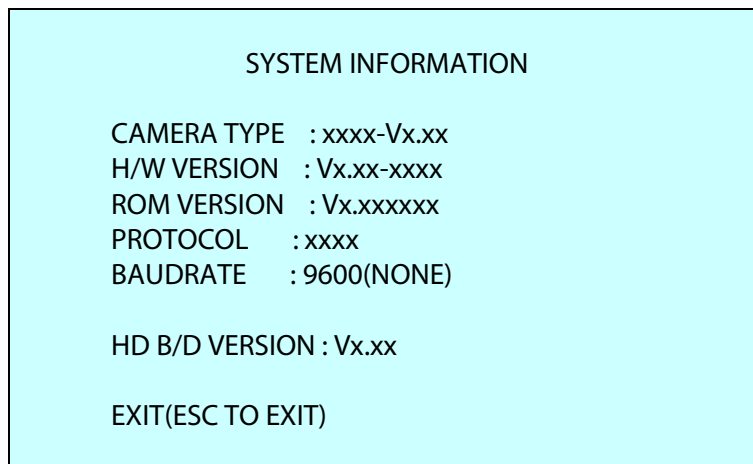

The system information provides essential information about the dome camera if service is required. This screen displays the camera type and ROM version. The information on this screen cannot be modified.

# Appendix A — Dimensions

Units: Inch (mm)

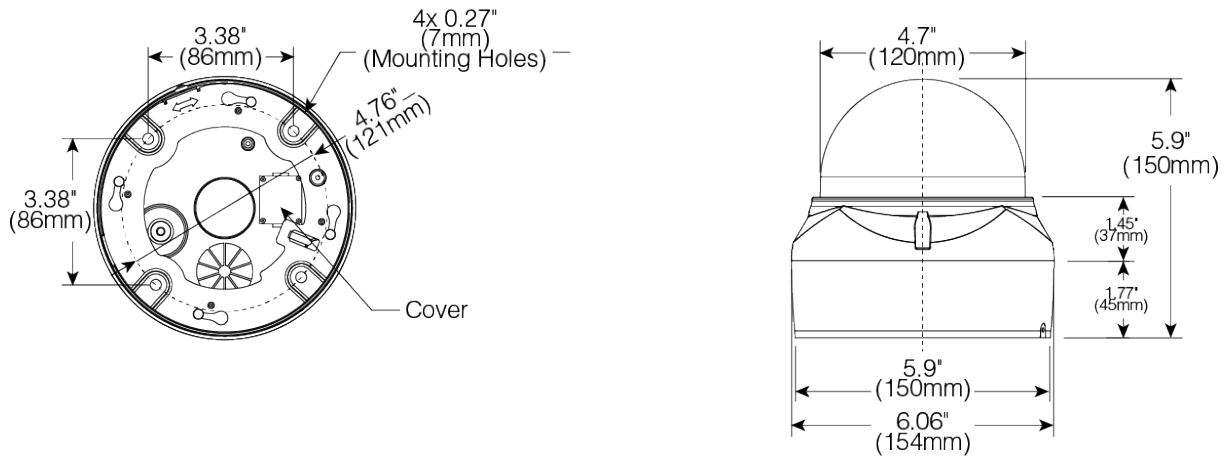

Figure – Dimension

## Appendix B — Troubleshooting

If problems occur, verify the installation of the camera with the instructions in this manual and with other operating equipment. Isolate the problem to the specific piece of equipment in the system and refer to the equipment manual for further information.

Problem	Possible Solution
No video.	Verify that power is connected to all pieces of equipment in the system. Verify that the power switches are in the ON position. Check the video connections.
Poor video quality.	Check that the BNC connectors are inserted properly. Check the voltage level of the dome camera. Cable for video is shielded.
Dome cameras lose their positions.	Reset the cameras using the Dome configuration menus. Check that the dome cameras are inserted properly in the base. Check the voltage level of the dome camera.



Headquarters Office: 5436 W Crenshaw St, Tampa, FL 33634  
Sales Office: 16220 Bloomfield Ave., Cerritos, California, USA 90703  
PH: 866-446-3595 | FAX: 813-888-9262  
[www.Digital-Watchdog.com](http://www.Digital-Watchdog.com)  
[technicalsupport@dwcc.tv](mailto:technicalsupport@dwcc.tv)  
Technical Support PH:  
USA & Canada 1+ (866) 446-3595  
International 1+ (813) 888-9555  
French Canadian 1+ (514) 360-1309  
Technical Support Hours: Monday-Friday  
9:00am to 8:00pm Eastern Standard Time